

ASSEMBLY AND INSTALLATION INSTRUCTIONS

T0517 T0518 T0519 T0522 T0523 T0524

WARNING: TO AVOID RISK OF ELECTRICAL SHOCK, BE SURE TO SHUT OFF POWER WHILE INSTALLING OR SERVICING THIS FIXTURE.

NOTE: 1. Before installing, consult local electrical codes for wiring and grounding requirements.
2. READ AND SAVE THESE INSTRUCTIONS.

Hardware Package (included):

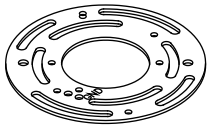

Mounting plate (A)



Mounting Screw (B)



Wire Connector (C)

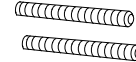

Headless screw (D)



Green Grounding Screw (E)



Lock Nut (F)



Ball Nut (G)



Rubber Pad (H)

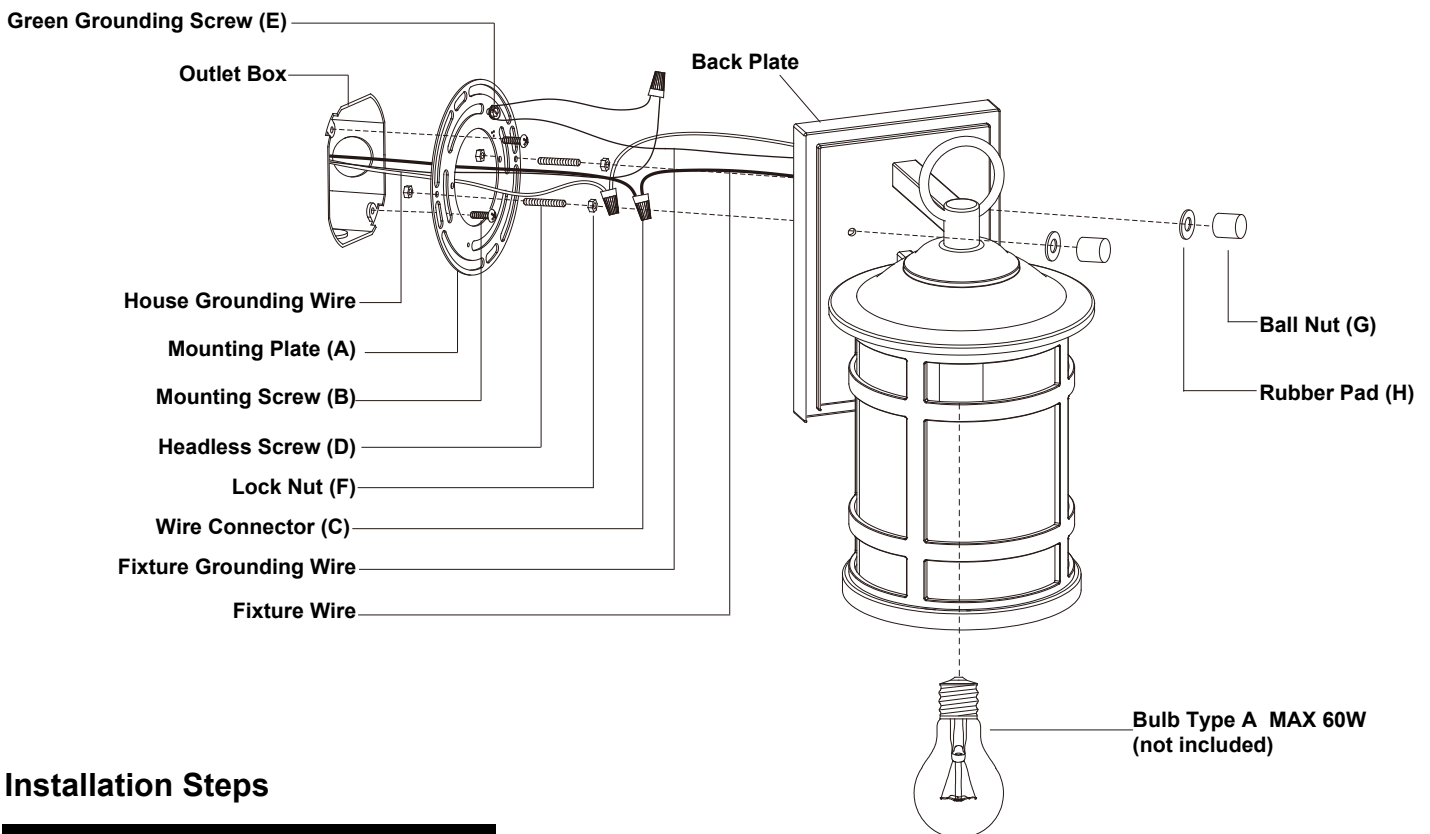

Installation Steps

Turn off the power at fuse or circuit box

1. Thread two headless screws (D) through the mounting plate (A), and then secure them with four lock nuts (F) (two on each side of the mounting plate (A).) Adjust the length of the headless screws (D) if necessary.
Note: Make sure the headless screws are lined up horizontally to make the fixture will be level.
2. Attach the mounting plate (A) to the outlet box by using two mounting screws (B).







3. Pull out the source wires and the house grounding wire from the outlet box. Make wire connections using the wire connectors (C):
 - Connect the black wire from the fixture to the black wire from the power source.
 - Connect the white wire from the fixture to the white wire from the power source.
 - Attach the fixture grounding wire to the mounting plate (A) with the green grounding screw (E). Then connect it to the house grounding wire with a wire connector (C).
 Carefully put the wires back into the outlet box.
4. Attach the fixture to the mounting plate (A) by inserting headless screws (D) into holes on back plate, and then secure it with two rubber pads (H) and two ball nuts (G).

NOTE: With silicone caulking compound,caulk complete around the back plate meets with the wall surface to prevent water from seeping into the outlet box.
5. Install a bulb (not included). See relamping label at socket area or packaging for maximum allowed wattage.

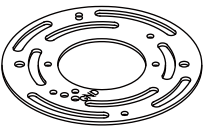
Turn on the power at fuse or circuit box

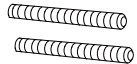
The following parts are available for re-order if damaged or missing.

Spare Parts List:

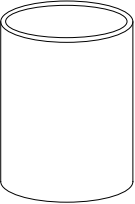
				<p>←</p> <p>Mounting Hardware 6128MM (1 SET) foT0517 T0518 T0519 6129MM (1 SET) foT0522 T0523 T0524</p>
Mounting plate (A)	Mounting Screw (B)	Wire Connector (C)	Headless screw (D)	
				<p>Glass 10104CS for T0517 T0522 10105CS for T0518 T0523 10106CS for T0519 T0524</p>
Green Grounding Screw (E)	Lock Nut (F)	Ball Nut (G)	Rubber Pad (H)	

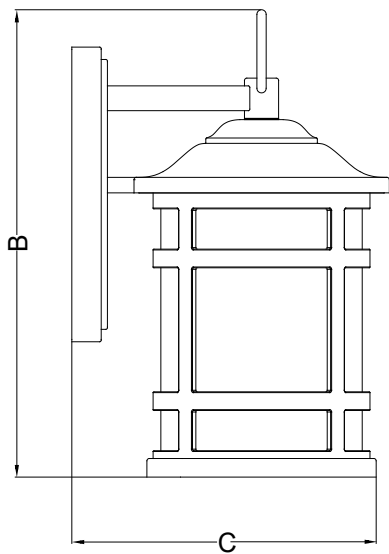
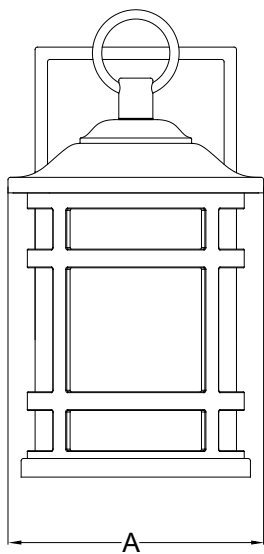

T0517	T0518	T0519
T0522	T0523	T0524
A: 5-1/2"	A: 6-1/4"	A: 8-1/2"
B: 9-1/2"	B: 11-3/4"	B: 14-3/4"
C: 7"	C: 8"	C: 10-1/2"