

WAREHOUSE 12" 2-LIGHT STEM HUNG PENDANT LIGHT

MSD182

FEATURES + BENEFITS



- Metal RLM shades are spun from heavy duty aluminum.
- Polyester powder coat finish provides color retention and scratch resistance.
- White powder coat shade interior for maximum light output.
- Painted Galvanized finish has Painted Galvanized shade interior.
- Dimmable with a dimmable bulb and compatible dimmer (not included).
- Standard 12" Stem included.
- UL Listed for Wet Location.
- Warranty: Limited 1 Year.
- Made in USA.

SPECIFICATIONS

Product Dimensions:

Width 12 1/8", Shade Height 7", Length 35 1/8", Canopy Dia. 4 1/8", Overall Height=Choice of Vertical Stem Length + 9 3/4"

Lamping:

100W Medium Base per socket

Options:

- Finish: 40-Slate Gray, 41-Black, 42-Forest Green, 44-White Gloss, 48-Sea Green, 49-Painted Galvanized, 50-Navy, 51-Architectural Bronze, 54-Light Blue, 55-Barn Red
- Stem Length: T24-3/4" IPS x 24", T30-3/4" IPS x 30", T36-3/4" IPS x 36", T48-3/4" IPS x 48"
- Integrated LED: L12-10W, 800 Lumen, 95CRI, Adjustable CCT.
- Other Accessories: B01-Decorative Canopy Cover, B02-Sloped Ceiling Mount, G05-Clear Weathertight Glass and Guard, W12-Wire Grill

Shipping:

At Montclair Light Works we proudly manufacture, assemble, and ship your lamp within 3 weeks from our factory in Montclair CA.

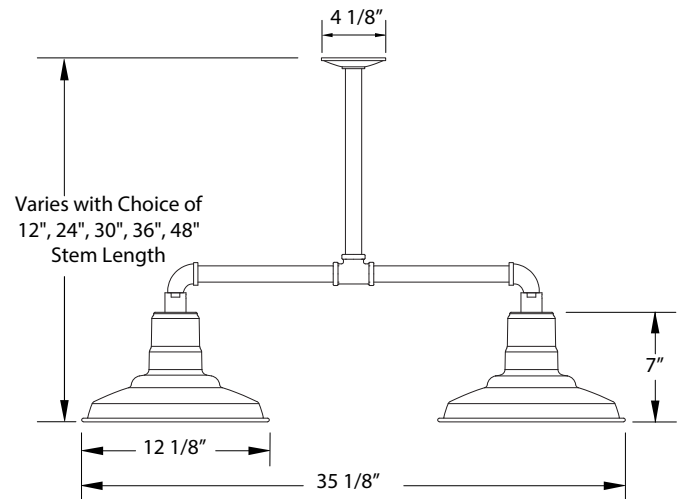

JOB/LOCATION

QUANTITY

DATE

NOTES